

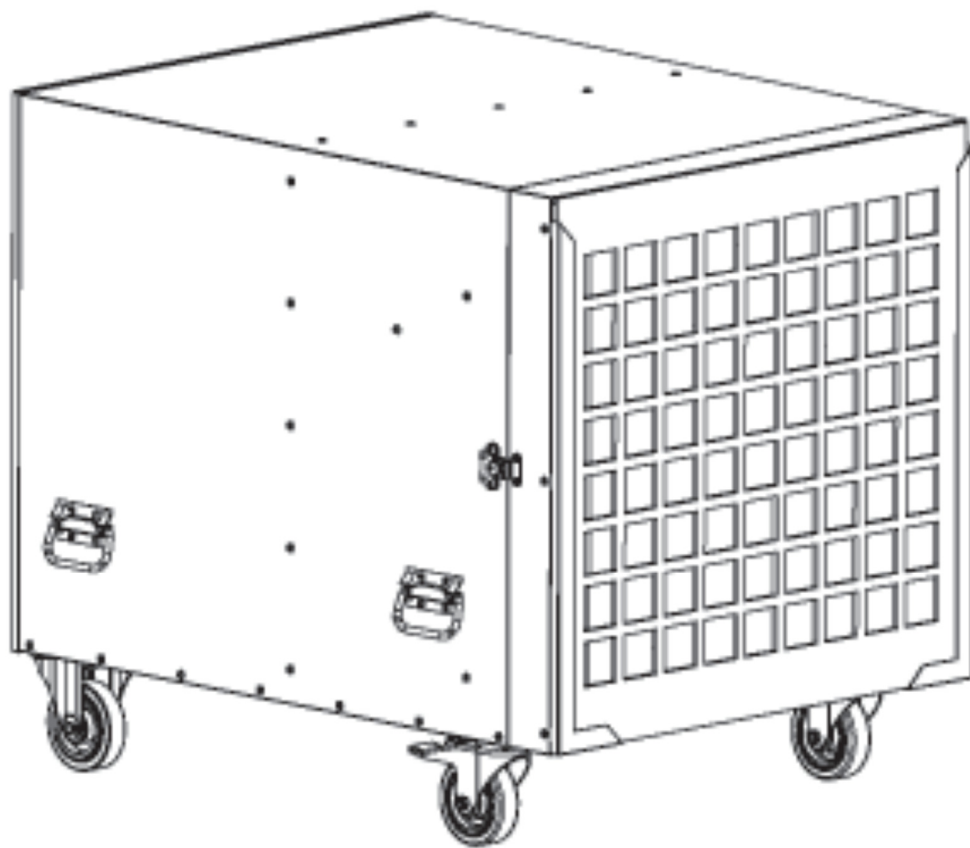

HEPA-AIRE[®] Portable Air Filtration Unit **H2KM and H2KMA**



Instruction Manual

Abatement Technologies, Inc.

Abatement Technologies, Inc.
Georgia, USA
800-634-9091

Abatement Technologies, Ltd.
Ontario, Canada
905-871-4720

www.abatement.com

READ and SAVE THESE INSTRUCTIONS!

Note:

1. **Read and understand all operating instructions before using the portable air filtration unit.**
 2. **Save this manual for future reference.**
-

This instruction manual provides important information on operation of the Abatement Technologies HEPA-AIRE® Portable Air Filtration Unit. These instructions must be carefully followed in order to operate the units safely and correctly. If you have any questions regarding the use or care of this equipment call Abatement Technologies at +1 800-634-9091 (U.S.) or +1 905-871-4720 (Canada) for assistance.

Abatement Technologies strongly recommends users of the room air filtration units and accessories to follow the most recent guidelines and/or standards published by the: Occupational Safety and Health Administration, Centers for Disease Control and Prevention, Environmental Protection Agency, American Society of Heating, Refrigerating and Air Conditioning Engineers, and all other federal, state, provincial and local regulations.

Note: The U.S. Environmental Protection Agency’s publication “Guidance for Controlling Asbestos-Containing Materials in Buildings”, EPA 560/5-85-024, includes helpful information on air filtration systems. Abatement Technologies strongly urges anyone performing asbestos abatement to read the most recent edition of this EPA publication before using any air filtration system.

TABLE OF CONTENTS

Safety Instructions	1
Requirements For Safe Operation.....	1
Important Safety Instructions.....	1
General Information.....	2
Standard Air Filter Stages (Supplied With the Unit).....	2
Alternate Filters (Purchased Separately).....	3
Determining the Required Number of Air Filtration Devices (AFD)	3
Electrical Requirements	4
Key Components	4
Key Component Descriptions.....	5
Operating the Unit	5
Before Operating the Unit	5
Modes of Operation	5
Control Panel	6
Starting the Unit	7
Transporting the Unit	7
User Servicing Instructions	7
Filter Replacement.....	7
Filter Change Indicator	8
Filter Change Procedure.....	8
Component Replacement and Care of the Unit.....	9
H2KM and H2KMA Specifications	10
Troubleshooting Guide.....	11
Certification of Room Air Filtration Units.....	12
Limited Warranty.....	12
HEPA Certification	12
H2KM and H2KMA Diagrams	13

SAFETY INSTRUCTIONS

REQUIREMENTS FOR SAFE OPERATION

1. Never allow unauthorized individuals or children to operate the unit at any time.
2. Abatement Technologies urges anyone operating HEPA-AIRE® Portable Air Filtration Units to wear the proper personal protective equipment and follow safe work practices in accordance with federal, state, local, provincial and employer regulations.
3. Check the condition of power cord(s) before using them. Damaged cords can cause fatal electric shock and/or motorized impeller failure.
4. Power cord(s) should never be exposed to water, heat, and/or sharp or abrasive objects. In addition, they should never be kinked or crushed. Avoid tightly wrapping the cords to prevent kinking of the internal wires. Always replace damaged power cords immediately.
5. Never pull the unit by the power cord.
6. Avoid running over power cords with utility equipment and vehicles.

 If the equipment is used in a manner not specified by the manufacturer, the protection provided by the equipment may be impaired.

IMPORTANT SAFETY INSTRUCTIONS

- a. Do not operate any unit with a damaged cord or plug. Discard unit or return it to an authorized service facility for examination and/or repair.
- b. Do not run cord under carpeting. Do not cover cord with throw rugs, runners, or similar coverings. Do not route cord under furniture or appliances. Arrange cord away from traffic area and where it will not be tripped over.

 **Caution:** As with any piece of electrical equipment, always make sure that the unit is turned “OFF” prior to connecting the power cord to an electrical outlet or disconnecting it from an electrical outlet. Failure to do so will cause “arcing”, and could result in personal injury, fire hazards and/or damage to the unit. Do not disconnect the power cord from supply receptacle while the unit is operating.

 **Warning:** To reduce risk of electrical shock, do not expose this unit to water or rain. Do not touch the electrical outlet or power cord(s) with wet hands or while standing on a wet or damp surface.

 **Warning:** Risk of electrical shock! Can cause injury or death! Turn unit “OFF” and disconnect power cord from supply receptacle before replacing the HEPA filter and before cleaning or servicing the unit.

 **Warning:** To reduce the risk of fire, electric shock, or injury to person observe the following: Use this unit only in the manner intended by Abatement Technologies. If you have questions, contact Abatement Technologies at +1 800-634-9091 (U.S.) or +1 905-871-4720 (Canada).

 **Warning:** This unit is equipped with an automatic restart motorized impeller that will restart without warning after a temporary power interruption or recovery from a thermal overload (over-heating) condition. Keep clear of the motorized impeller at all times to reduce the risk of injury.

 **Warning:** To reduce risk of fire or electrical shock, do not use this unit with any solid-state speed control device. Do not use in a cooking area.

 **Warning:** Do not position the unit so that it is difficult to operate the disconnecting device. The disconnecting device is the power cord plug.

 **Caution:** This unit is designed for indoor use only.

⚠ Caution: For General Ventilating Use Only. Do Not Use To Exhaust Hazardous Or Explosive Materials And Vapors.

⚠ Warning: Do not connect the unit's power cord to a supply receptacle unless the inlet and power modules are in their proper position and latched together.

⚠ Warning: Abatement Technologies air filtration systems are not intrinsically safe for use in hazardous environments. Always consult a certified industrial hygienist before using them. Do NOT use this equipment in any atmosphere that is or may be immediately dangerous to life or health (IDLH), combustible, flammable, explosive, oxygen deficient, and/or contains odors, vapors, gases or particulates that exceed permissible exposure levels. Such atmospheres may require the use of intrinsically safe equipment, specific engineering controls, and personal protective equipment in accordance with Occupational Safety and Health Administration (OSHA), Environmental Protection Agency (EPA), Canadian Standards Association (CSA), and other federal, state, provincial and local regulations.

⚠ Warning: This equipment is not classified as "intrinsically safe" and should not be used in the following hazardous locations as defined by the Underwriters Laboratories: Class I Division 1, Class I Division 2, Class I Zone 0, Class I Zone 1, Class I Zone 2, Class II Division 1, Class II Division 2, Class III Division 1, Class III Division 2. Refer to http://en.wikipedia.org/wiki/Electrical_equipment_in_hazardous_areas.

⚠ Warning: Do not use this unit near sparks, open flames or other possible sources of ignition.

GENERAL INFORMATION

The H2KM and H2KMA Portable Air Filtration Units are multi-use air filtration devices, equipped with pre-filters and a HEPA filter that are capable of filtering many airborne contaminants. An alternate carbon pre-filter for capturing low concentrations of odors, vapors, gases, and volatile organic compounds, collectively known as OVG, is also available.

Types of contaminants captured by particulate pre-filters, HEPA filter, or carbon filters:

- | | | |
|----------------|---------------------------|--|
| • Dirt | • Lung-damaging particles | • Low concentrations of OVG |
| • Dust | • Metal fumes | • Low concentrations of Volatile Organic Compounds (VOC) |
| • Drywall dust | • Smoke | • Unpleasant nuisance odors |
| • Saw dust | • Mold and fungal spores | |

Note: To capture low concentrations of OVG, a VAPOR-LOCK® carbon filter must be used.

The H2KM and H2KMA Portable Air Filtration Units are capable of providing particulate and odor, vapor, gas filtration with final stage filtration through a High Efficiency Particulate Air (HEPA) filter. These units incorporate a series of particulate filters that successively remove larger size to smaller size particles from the air. In addition to providing HEPA filtration, the H2KM and H2KMA units are primarily used in a negative pressure or recirculation mode. A negative pressure condition is created in order to confine contaminated airborne particles. This condition exists when the static pressure inside the room containing the unit is lower relative to the pressure of the environment outside the room. The static pressure differential is created and maintained by continuously exhausting air out of a given room at a faster rate than air enters the room from all other sources. In the recirculation mode, all of the filtered air is exhausted back into the room containing the unit.

STANDARD AIR FILTER STAGES (SUPPLIED WITH THE UNIT)

The H2KM and H2KMA come equipped with three progressively efficient particulate filters. The first and second stage filters mount in the pre-filter access door channel and the final stage HEPA filter is located inside the cabinet:

- First stage. 1" coarse particulate poly-pad is designed to capture particles 100 microns or larger (P/N: H2001).

- Second stage. 2" deep, pleated pre-filter is designed to capture up to 85% of particles 3-10 microns or larger (P/N: H2002).
- Final stage. HEPA filter is tested and certified to capture at least 99.97% (9,997 out of 10,000) 0.3-micron particles (P/N H242406-99).

Note: The particulate filters included with this unit do not remove odors, vapors or gases, including volatile organic compounds.

ALTERNATE FILTERS (PURCHASED SEPARATELY)

There are two alternate filters that can be used in both the H2KM and H2KMA:

- Second stage. 2" deep, VAPOR-LOCK® pleated high-capacity carbon filter for capturing OVG and particles 10 microns or larger. This mounts in the pre-filter channel (P/N VL2024).
- Final stage. 11½" deep, galvanized steel frame HEPA filter tested & certified to capture at least 99.97% of 0.3-micron particles (P/N H2010M).

⚠ Filters can be used in any combination as long as one first stage, one second stage, and one final stage filters are installed during operation.

VAPOR-LOCK® pleated, high-capacity, carbon filters (part # VL1002) are available for capturing OVG. This 2"-deep filter can be used as an alternate second stage pre-filter to reduce airborne OVG by chemically bonding the OVG molecules to the surface area of the carbon granules via a process known as adsorption. The VL1002 filter also provides a similar level of particulate filtration efficiency to the H502 pre-filter.

Effective carbon adsorption is dependent upon the amount of carbon & exposed carbon granule surfaces, and the dwell (contact) time the OVG molecules have with the carbon granules. Operating the unit at lower speed settings to increase dwell time can therefore improve OVG adsorption, though it is highly unlikely that all of the OVG will be removed in one pass of air through the unit. Operating the unit in the recirculation mode can increase effectiveness, by exposing OVG particles to multiple passes through the VAPOR-LOCK® filter.

It is almost impossible to provide accurate estimates to two commonly asked questions: "how much time will it take to capture all of the OVG?", and "how do I know when a carbon filter should be replaced?" Unfortunately, unknown factors – such as concentration levels, fresh-air intake volume, temperature, and humidity – prevent establishment of any more accurate 'rule of thumb' than one's sense of smell. Since off-gassing of adsorbed OVG can occur when the adsorption capacity of the filter is reached, replace the carbon filter as soon as odor breakthrough is sensed. More detailed information on carbon adsorption can be found in an article titled: "Activated Carbon: How Is It Used? How Does It Work?" which can be found on the Abatement Technologies website, www.abatement.com.

DETERMINING THE REQUIRED NUMBER OF AIR FILTRATION DEVICES (AFD)

1. Calculate the total air volume (V) in cubic feet (ft³) within the enclosed containment area by multiplying the length (L) x the width (W) x the height (H), all in feet ($V = L \times W \times H$).
2. Determine the minimum number of air changes per hour (ACH) specification. When no ACH number is specified, most users target at least 6 ACH for construction areas. A good practice is to build in a safety factor to compensate for filter loading, duct losses, reduced voltage, and other factors that can reduce actual installed airflow. For example, if 6 ACH is the objective, enter 7.5 ACH for a 25% safety factor, enter 9 ACH for a 50% safety factor, or enter 10.5 for a 75% safety factor.
3. Select an Abatement Technologies room air filtration device (AFD) model and determine the peak airflow rating for that model in cubic feet per minute (CFM).
4. Determine the total number of AFD required using the following formula: $\text{Quantity} = (V \times \text{Design ACH}) / (\text{AFD Rating} \times 60)$
5. Always round up to the next whole number. For example, if the total number of AFD required is 1.32, 2 units are recommended, not 1.

Example: How many air filtration devices (each with 2000 CFM rated airflow) would be required to provide 7.5 ACH (including a safety factor) in a 40' x 42' x 12' containment area?

1. $V = 48 \text{ ft} \times 50 \text{ ft} \times 8 \text{ ft} = 19200 \text{ ft}^3$
2. Design ACH = 7.5
3. Quantity of AFD required = $(19200 \text{ ft}^3 \times 7.5 \text{ ACH}) / (2000 \text{ CFM} \times 60) = 144000/36000 = 1.2 \text{ units}$
4. 1.2 units → 2 units required.

ELECTRICAL REQUIREMENTS

1. The H2KMs and H2KMAs require a minimum of 110 volts AC, 60 Hz to operate properly; however, maximum air flow performance requires 120 volts AC, 60 Hz.
2. Due to momentary start-up current surge, the unit requires a 15 amp circuit that is free of other loads.
3. If the unit is connected to a circuit that is protected by fuses, use time delay fuses.
4. Extension cords used for this unit must be UL-listed, heavy duty No. 12/3 AWG SJTW industrial grade 3-wire type. Use of larger numerical gauge (lower capacity wire) power cord(s) may result in electrical shock, fire hazards and/or damage to unit. The cord(s) must be in good condition and in continuous lengths (no splicing) and should not exceed a total of 50 feet (15 meters) in length. Make certain that any extension cords used do not reduce power to the unit to less than 110 volts. Use of a voltmeter to confirm adequate voltage is recommended.
5. Check to ensure that any circuit to which the unit is connected is protected by a 15 amp circuit breaker.
6. The units should be connected to a three-prong, properly grounded electrical outlet equipped with a Ground Fault Circuit Interrupt (GFCI) device. A GFCI is an electrical safety device that will trip the circuit and stop the flow of electricity if leakage of current is detected.
7. To avoid personal injury, fire hazards, and/or damage to the units' electrical system and power cord, do not connect or disconnect the power cord to an electrical outlet unless the unit is switched to the "OFF" position.

KEY COMPONENTS

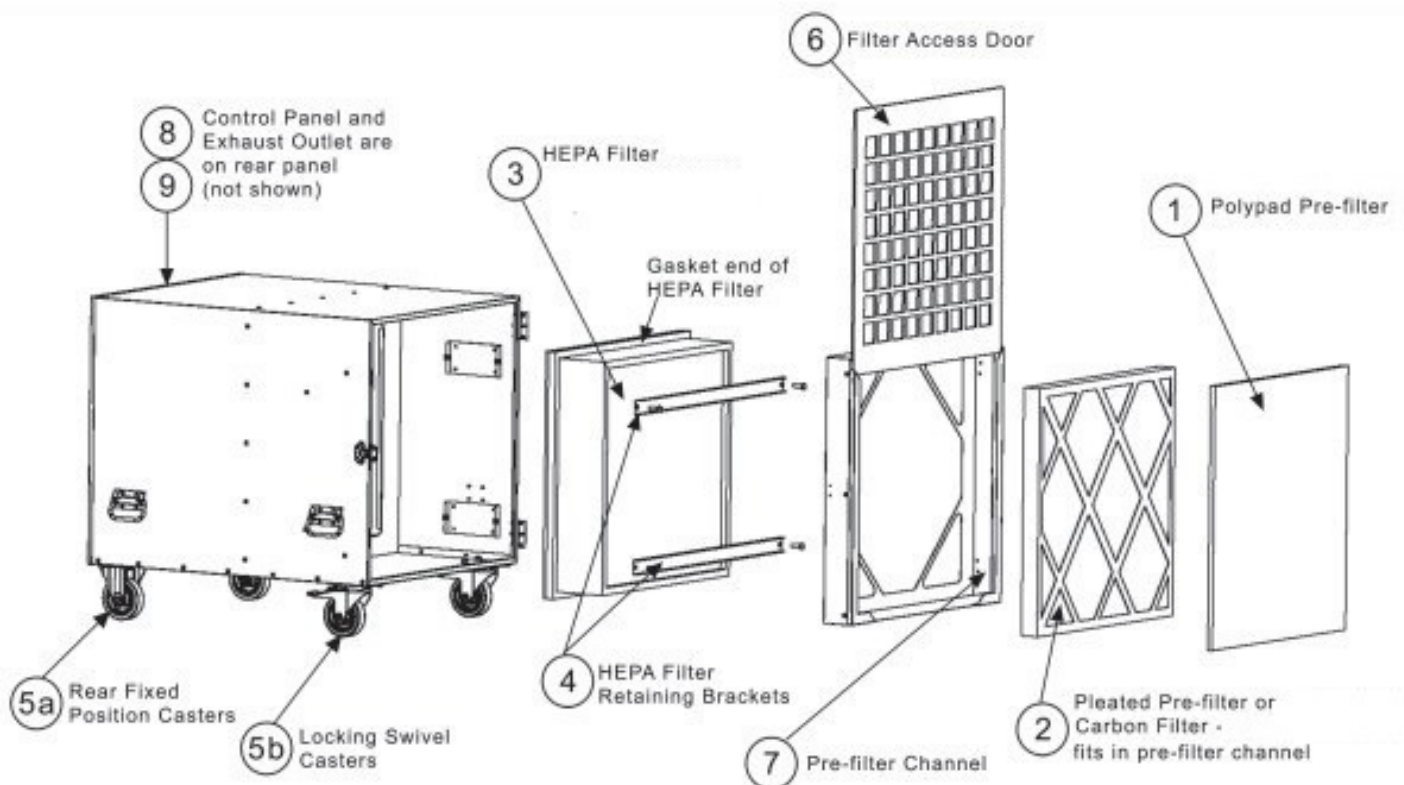

KEY COMPONENT DESCRIPTIONS

1. First Stage Filter. 1" Coarse/Particulate Polypad Pre-filter (P/N: H2001).
2. Second Stage Filter. 2" Pleated Particulate Pre-filter (P/N: H2002).
 - Alternate 2" High Capacity Carbon Filter (P/N: VL2024).
3. Final Stage Filter. 6" deep 99.97% HEPA filter (P/N: H242406-99).
 - Alternate 11 1/2" deep, 99.97% HEPA filter (P/N: H2010M).
4. HEPA filter retaining brackets.
5. Casters.
 - a) 2 each 4" fixed position casters
 - b) 2 each 4" 360° swivel casters with locking feature
6. Filter access door.
7. Pre-filter channel.
8. Control panel – on rear panel of the unit.
9. 12" exhaust outlet - on rear panel of unit.

OPERATING THE UNIT

BEFORE OPERATING THE UNIT

Units should be secured in place in the location of use using the locking casters (2) mounted on the bottom of the unit.

1. Press down on caster flange with work shoe until flange locks in downward position. Once locked, the caster will not roll or swivel.
2. Tap with work shoe to release caster from locked position.

 **Warning: Pinch Hazard!** Do not use hands or fingers to lock or unlock the swivel caster or personal injuries such as severe pinching or cuts could result. Use work shoe to lock and unlock caster.

Inspect and tighten any HEPA filter retaining bolts that may have loosened during transportation. Inspect the filters for any material or structural damage prior to use and replace any damaged filters before operating the unit. When removing any filters prior to operation, always put them back in place with the airflow indicator on the filter housing oriented in the proper direction (if applicable).

As with any air filtration system, external airflow losses not attributable to the air filtration unit will reduce the airflow of the system. The following recommendations can minimize airflow losses created by external static resistance.

1. Always use the minimum length of ducting possible with the fewest possible number of turns and bends.
2. Rigid metal ducting creates less turbulence and consequently less airflow loss than flexible ducting. Regardless of the type of ducting used, rigid, "sweep-type", radiused connections should be used for all turns and bends.
3. If flexible ducting is used, it must be kept as taut as possible to avoid flattening.

MODES OF OPERATION

1. **Negative Pressure** – used to help ensure that airborne contaminants do not escape from a contained area by maintaining negative (lower) air pressure within that area compared to adjacent areas. Any air leakage will be an inflow of external air, not an outflow of contaminated air. To ensure that the proper pressure differential is maintained, the volume of HEPA-filtered air exhausted from the containment area must be the greater of 10% or 100 CFM higher than the volume of air entering. This pressure differential can be established by:
 - a. placing the unit inside the containment area and using it to push air out of the containment area. Attach flex duct at the outlet collar and exhaust the HEPA-filtered air outside of the containment area according to regulations – outdoors or another location within the building.
 - b. placing the unit outside of containment area and using it to pull air out of the area. Attach flex duct between the inlet collar (sold separately, P/N: H2080P) and the containment area.

2. **Recirculation** – used to reduce concentrations of airborne contaminants in a room or area by continuously cleaning the air and exhausting it back into the same room or area.
3. **Positive Pressure** – used to help prevent airborne contaminants from entering a containment area by maintaining positive (higher) pressure within that area compared to adjacent areas. Any air leakage will be an outflow of clean air, not an inflow of external air. To ensure that the proper pressure differential is maintained, the volume of HEPA-filtered air supplied to the area must be the greater of 10% or 100 CFM higher than the volume of air exhausted. This pressure differential can be established by:
 - a. placing the unit inside the containment area and using it to pull air into the containment area. Attach flex duct between the inlet collar (sold separately, P/N: H2080P) and a location outside of the containment area.
 - b. placing the unit outside of containment area and using it to push HEPA-filtered air into the area. Attach flex duct at the outlet collar and exhaust the HEPA-filtered air inside of the containment area.

If the room air filtration units are being used to create and maintain a negative/positive pressure condition, the pressure differential between the negative/positive room and the environment outside the room should be monitored with a calibrated instrument as per OSHA/CDC requirements. The Abatement Technologies Portable Pressure Monitors are recommended to ensure that requirements are being met.

Important Note: Do not operate the unit unless the pre-filter(s) and HEPA filter are installed and the filter access door and panel are in place and closed.

CONTROL PANEL

1. **Power Cord** - Hardwired, 8 ft 18/3 AWG SJTW power cord for connection to electrical outlet.
2. **Motor Speed Switch** - Three position switch, “HIGH”, “OFF” (middle position of switch), and “LOW”, that controls the speed of the motor.
3. **Filter Change Indicator** - Amber light that indicates excessive restriction on intake or loading of the filter(s) and that filter change procedures should be followed.

Note: Check the Filter Loading Indicator when the unit is operating on “HIGH” speed.

4. **Audio Alarm Switch** (H2KMA only) – Rocker-arm style switch that turns the Filter Change Audio Alarm “ON” and “OFF”.
5. **Differential Pressure Gauge** (H2KMA only) - Indicates total system differential pressure in inches of water column (WC). An increase in differential pressure indicates excessive restriction on intake or loading of the filter(s) and that filter change procedures should be followed. Check the gauge when the unit is operating on “HIGH” speed. With clean filters the reading will be about 1.5" WC. The alarm will sound at a reading of about 2.2" WC. Max static/total blockage reading will be about 2.9" WC.

Not Shown - Filter Change Audio Alarm (H2KMA only) - Tone that indicates excessive restriction on intake or loading of the filter(s) and that filter change procedures should be followed.

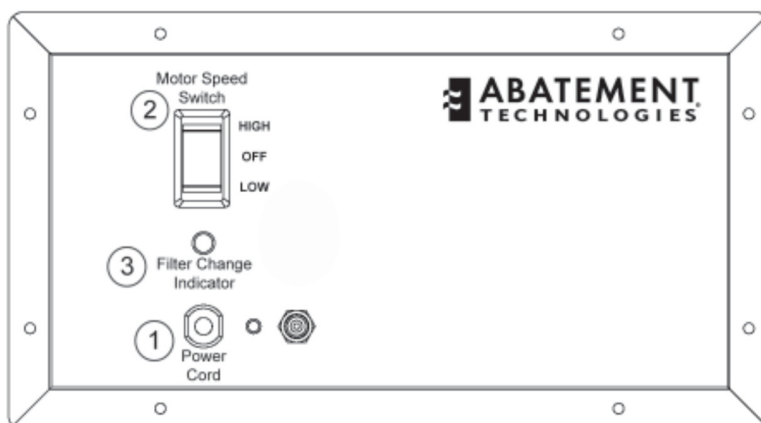

H2KM Control Panel

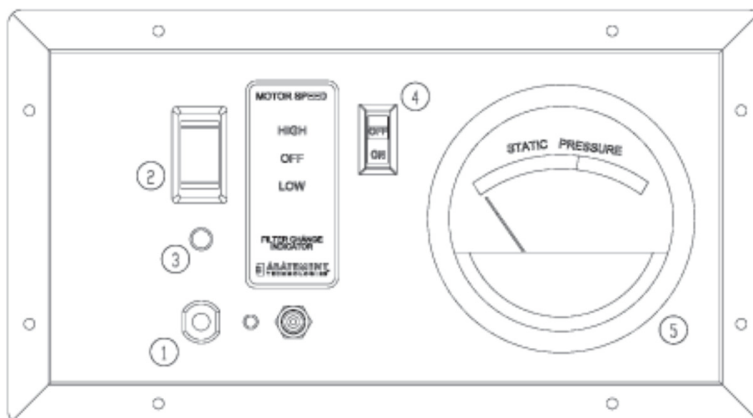

H2KMA Control Panel

STARTING THE UNIT

1. Check to make sure that the Motor Switch is in the “OFF” (middle) position. Plug the power cord into a 120 volt AC, 60Hz, 15 amp supply circuit.
2. Set the Motor Speed switch to the “HIGH” or “LOW” position.
Note: Refer to the chart in this instruction manual entitled H2KM and H2KMA SPECIFICATIONS that lists the airflows for the H2KM and H2KMA.

Note: In the event of a power failure while the unit is running, or loss of power due to any other cause, this unit’s motorized impeller will re-start when power is restored, after a brief delay.

TRANSPORTING THE UNIT

The H2KM and H2KMA Portable Air Filtration Units should be transported in its normal position (resting on its casters). If extremely poor road conditions exist, or excessive shock and vibration are expected, take precautionary measures by padding the unit to provide impact absorption during transport.

⚠ Caution: Always use caution when moving the H2KM and H2KMA Portable Air Filtration Unit inside a building or home. The unit weighs 124 pounds (141 pounds with H2010M installed). Older structures with weakened floors or staircases may require special considerations for safe transport.

USER SERVICING INSTRUCTIONS

Abatement Technologies’ portable air filtration units are designed to be low maintenance devices and basic maintenance should be performed as follows:

- Filters should be changed as needed based on the filter change indicator light or gauge reading. Follow the FILTER CHANGE PROCEDURE as described in this manual. Filters can be changed earlier, if desired, to maintain a minimum required flow rate.
- The unit should be cleaned with a damp cloth or a water-based cleaner/sanitizer as needed. Do not use harsh chemicals, solvents, or detergents to clean the unit.

⚠ Warning: Keep electrical components dry as their exposure to liquids poses a safety hazard and can damage components.

FILTER REPLACEMENT

Note: Personnel responsible for changing filters, servicing units or relocating units within the facility are urged to wear the proper personal protective equipment (PPE) and follow safe work practices in accordance with federal, state, provincial, local and employer regulations. Abatement Technologies cannot recommend the type of PPE required as that will need to be determined by safety/risk assessment personnel based on various risk factors, including the type of particulates being captured by the air filtration device and the surrounding environment where the units are being used, transported, or serviced.

Note: Filters being replaced must be disposed of in accordance with federal, state, provincial, local and facility regulations.

System airflow reduction is generally the result of filter loading, blockage of the unit’s inlet or use of excessive lengths of flex duct.

The size and concentration of airborne contaminants, temperature and humidity conditions, and duration of use determine how often filters need replacement. If the Pre-filter Change Indicator on the control panel illuminates, the Filter Change Audio Alarm sounds, and/or the Differential Pressure Gauge displays a reading of 2.2” WC or higher this indicates one or more of the following: (1) pre-filter(s) are loaded, (2) the inlet is obstructed, and/or (3) the flex duct, if attached to inlet, is too long or has too many bends. If the HEPA Filter Change Indicator on

the control panel illuminates, this indicates one or more of the following: (1) HEPA filter is loaded, (2) the inlet or outlet is obstructed, and/or the flex duct, if attached, is too long or has too many bends.

If using an activated carbon filter, the method of determining when to replace this particular filter is somewhat subjective. As the odor, vapor, and/or gas filtration capacity decreases, the user will begin to sense a slight odor or taste of the contaminant, indicating that the filter should be replaced.

Note: The filters are not reusable, therefore, do not attempt to clean and reuse them.

⚠ Caution: Abatement Technologies HEPA-AIRE® Portable Air Filtration Units are designed to meet or exceed standards for high efficiency air filtration equipment. Use only Abatement Technologies parts, including replacement filters. **Use of non-Abatement Technologies parts and filters voids the product warranty and all performance claims.**

⚠ Warning: To reduce the risk of fire, electrical shock or personal injury, always turn the unit "OFF" and disconnect the power cord from supply receptacle before replacing the HEPA filter and before cleaning or servicing the unit.

Filter Change Indicator

The Filter Change Indicator light illuminating (all models), Audible Alarm tone sounding (H2KMA only), and/or a differential pressure reading of 2.2" WC or greater on the Differential Pressure Gauge (H2KMA only), indicate one or more of the following:

1. Loaded filter(s). Refer to FILTER CHANGE PROCEDURE.
2. Restrictions on air intake. Refer to TROUBLESHOOTING GUIDE.

Note: The Filter Change Audio Alarm can be deactivated by turning the Audio Alarm Activation Switch "OFF".

Filter Change Procedure

The Filter Change Indicator light located on the control panel will indicate when one or more of the filters need to be changed. This is based on a factory setting and the filters can be changed earlier, if desired, to maintain a minimum air flow requirement. Since the Filter Change Indicator Light is based on the pressure drop across all of the filters, it cannot indicate specifically which filter needs to be changed. Therefore, when the Filter Change Indicator Light illuminates, the first stage filter should be changed first to see if the light turns off. If the light remains, then the second stage filter should be changed. If the light remains, then the HEPA filter should be changed.

Changing the First Stage Filter:

1. With the unit operating, remove the plastic door grill protecting the pre-filter chamber.
2. Remove the first stage filter and replace it with a new one.
3. Drop the access door grille back into the metal frame on the unit inlet. Make sure it is flush and fully seated in the frame.
4. If the Filter Change Indicator light remains "ON", the Filter Change Audio Alarm sounds, and/or the Differential Pressure Gauge displays a reading of 2.2" WC or higher, after changing the first stage filter, the second stage filter should be replaced.

Changing the Second Stage Filter:

1. With the unit operating, remove the plastic door grill protecting the pre-filter chamber.
2. Remove the second stage filter (located behind the first stage polypad filter) and replace it with a new one.
3. Return the first stage filter into place in front of the new second stage filter and replace the plastic door grill.
4. If the Filter Change Indicator light remains "ON", the Filter Change Audio Alarm sounds, and/or the Differential Pressure Gauge displays a reading of 2.2" WC or higher, after changing the second stage filter, the HEPA filter should be replaced.

Note: If an alternative VAPOR-LOCK filter is being used, be sure to remove it from its poly bag before installing it in the unit. VAPOR-LOCK filters are packaged in poly bags to preserve the integrity of the carbon granules.

Changing the H242406-99 HEPA Filter:

1. Turn the unit "OFF" and disconnect the unit's power cord from the electrical outlet.
2. Unlatch and open the Filter Access Door.
3. Remove the bolts that secure the HEPA filter retaining brackets in place (remove the lower bracket first, then the top bracket), set the brackets aside, and remove the HEPA filter from the cabinet.
4. Carefully install a new HEPA filter inside the cabinet, gasketed end first. Ease the filter into the cabinet until it is flush against its sealing surface. For reference purposes, the top panel of the H242406-99 filter has various labels affixed to it and the rear of the filter is the gasketed end.
5. Re-attach the HEPA filter retaining brackets to secure the filter in its proper position. The top bracket should be re-attached first, then the bottom bracket. The bolts should be snug but not over-tightened.
Note: The HEPA filter is delicate and should be handled with care. When removing or re-attaching the HEPA filter retaining brackets, do not touch the filter media; otherwise, damage to the filter and leakage of contaminated air could result.
6. Close and securely latch the Filter Access Door.

Changing the H2010M HEPA Filter

1. Follow the instructions above for changing the H242406-99 HEPA Filter. For the installation of this filter, note that the mounting pockets for the HEPA filter braces are located closer to the front of the cabinet to accommodate the deeper filter.

 **Warning:** Use only Abatement Technologies pre-filters, HEPA filters, and replacement parts. Substitute parts void the warranty, jeopardize worker and environmental safety, and adversely affect engineered performance levels.

COMPONENT REPLACEMENT AND CARE OF THE UNIT

 **Warning:** To reduce the risk of fire, electrical shock or personal injury, always turn the unit "OFF" and disconnect power cord from supply receptacle before removing the control panel, replacing the HEPA filter and before cleaning or servicing the unit. This unit is equipped with an automatic restart motorized impeller that will restart without warning after a temporary power interruption or recovery from a thermal overload (over-heating) condition. Keep clear of the motorized impeller at all times to reduce the risk of injury.

Occasionally a defective component will cause the unit to operate improperly or not at all. Any electrical component can fail. Refer to the Wiring Diagrams and Wiring Schematics to diagnose the failure of any component. Diagnostics should only be performed by a technician qualified to service electrical equipment.

The unit should be cleaned with a damp cloth or a water-based cleaner/sanitizer. Do not use harsh chemicals, solvents or detergents to clean the unit.

 **Warning:** Keep electrical components dry as their exposure to liquids poses a safety hazard and can damage components.

H2KM AND H2KMA SPECIFICATIONS

FEATURE	SPECIFICATIONS
Net weight with filters:	124 lbs. with H242406-99 HEPA; 141 lbs. with H2010M HEPA.
Shipping weight:	141 lbs.
Unit dimensions:	35.75" L x 26" W x 30.25" H
Power supply requirements:	120 VAC, 60 Hz, 15 A
Normal operating amps:	10 amps or less
Motor:	1 HP, 2 speed motor with thermal overload protection, auto re-set, 60 HZ, single phase.
Operating flow rate* (with clean filters):	Low Speed – 1,300 CFM High Speed – 2,000 CFM
Operational sound level:	70 dBA on high speed, reading taken at 5'.
Cabinet:	20 ga galvanized steel.
Transportability:	2 each removable 4", 360° swivel casters with locking feature. 2 each removable 4", fixed position casters.
Pre-filter access:	Swing out hinged door secured in place with cam latch.
First stage pre-filter:	1" coarse particulate polypad pre-filter (P/N: H2001).
Second stage pre-filter:	2" deep particulate pleated pre-filter (P/N: H2002).
Alternate second stage pre-filter:	2" deep high capacity carbon filter (P/N: VL2024)
HEPA filter:	Tested and certified to an efficiency of 99.97% or higher against 0.3 micron size particles (P/N: H242406-99)
Alternate HEPA filter:	Tested and certified to an efficiency of 99.97% or higher against 0.3 micron size particles (P/N: H2010M)
Flex duct connection:	Outlet: 12" nominal diameter port. Inlet: Not included with unit. Plastic adapter with a 12" nominal diameter port (P/N: H2080P).

Note: Specifications subject to change without notice.

*Airflow rating estimates are based on factory testing at 120 VAC, 60 Hz with an air straightener and a traverse of readings taken with a computing vane-anemometer. Actual results may vary for various reasons, including motor and blower and HEPA filter tolerances. Factors such as filter loading, reduced voltage to the motor, and inlet and outlet ducting will reduce airflow. Use the ratings as a general guideline only.

TROUBLESHOOTING GUIDE

PROBLEM	POSSIBLE CAUSE	SOLUTION
No response when the power is turned on	Power cord unplugged.	Plug power cord firmly into electrical outlet in wall.
	Defective power cord.	Check all connections and condition of cords. Do not operate with damaged power cord(s).
	Tripped circuit breaker.	Reset breaker for building.
	Tripped ground fault circuit interrupter or residual current device.	Reset GFCI/RCD at the power source.
	Thermal overload on the motorized impeller has tripped.	Turn unit "OFF", wait 30 minutes and restart unit.
Circuit breaker on control panel or building "trips".	Overloaded circuit.	Unplug any additional equipment connected to the circuit. Reset circuit breaker.
Unit rumbles when attempting to start.	Low voltage or limited amperage is supplied.	Check power supply. For maximum performance, the unit requires a 120 V, 15 amp circuit that is free of loads.
	Extension cord is too long or too high of a gauge.	Extension cord(s) should not exceed a total length of 50 ft. Use grounded 3-wire 12 gauge cord(s).
	Other machines or loads on same circuit.	Remove other loads from same circuit.
Filter change indicator is ON".	Loaded filters.	Change in accordance with operating instructions.
	Excessive restrictions.	Reduce bends, length of flex duct, or eliminate restrictions.
	If using a carbon pre-filter, carbon filter has not been removed from polybag.	Remove carbon filter from polybag.

Note: If the unit does not start or malfunctions after carefully following the TROUBLESHOOTING GUIDE, call Abatement Technologies service department at +1 800-634-9091 (U.S.) or +1 905-871-4720 (Canada) for assistance.

CERTIFICATION OF ROOM AIR FILTRATION UNITS

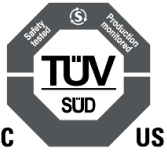

Abatement Technologies H2KM and H2KMA air filtration units are independently tested and certified to the relevant safety requirements by TÜV SÜD.

TÜV SÜD is accredited by the U.S Occupational Safety and Health Administration (OSHA) as a Nationally Recognized Testing Laboratory (NRTL).

LIMITED WARRANTY

Abatement Technologies, Inc (ATI) warrants that goods sold to the original user shall be free from defects in material and workmanship for a period of 1 year, except such as are commercially acceptable. This warranty does not include useful filter life. ATI does not warrant that the goods sold are merchantable or fit for any particular purpose. ATI makes no warranties other than as stated in this paragraph. All other warranties, guaranties, or representations, express or implied, by operation of law or otherwise, are expressly disclaimed. **Goods found by ATI to be defective or not to conform to specification shall upon return be replaced or repaired by ATI without any additional charges, or, at ATI's option, ATI may refund the purchase price of such goods. ATI will pay return transportation charges on returned goods not exceeding the transportation charges applicable to shipment from original destination unless the returned goods are free from defect and conform to specifications. Returned goods which are found by ATI to be free from defect and to conform to specifications shall be held for Purchaser's shipping instructions, which instructions Purchaser shall furnish promptly upon request.** ATI's liability shall in no event extend beyond replacement, repair or refund of the purchase price and ATI shall not be liable under any circumstances for special, contingent or consequential damages, nor for loss, damages, or expenses directly or indirectly arising from the use of the goods, including without limitation, warehousing, labor, handling and service charges, die, equipment, or machine breakage, nor for costs, lost profits or loss of good will. The use of substitute, non-ATI parts and/or filters, in any ATI product, voids all warranties and performance claims. The remedies set forth herein are exclusive.

For warranty information and assistance contact Abatement Technologies' Customer Service Department at +1 800-634-9091 (U.S.) or +1 905-871-4720 (Canada).

HEPA CERTIFICATION

Abatement Technologies' H2KM and H2KMA high-efficiency air filtration units are originally equipped with true HEPA (High Efficiency Particulate Air) filters designed to maximize the performance of the equipment, and to meet the following industry standards:

Institute of Environment Sciences and Technology
IEST-RP-CC001 (Type A HEPA and ULPA Filters)
IEST-RP-CC021 (Testing HEPA and ULPA Filter Media)

Underwriters Laboratories
UL900

100% Efficiency Tested

Abatement Technologies HEPA filters are individually tested and certified to ensure that the completed filter provides an overall minimum efficiency of 99.97% when challenged by a thermally generated test aerosol, 0.3-microns in size, in accordance with IEST-RP-CC034.

H2KM AND H2KMA DIAGRAMS

H2KM Control Panel Wiring Diagram

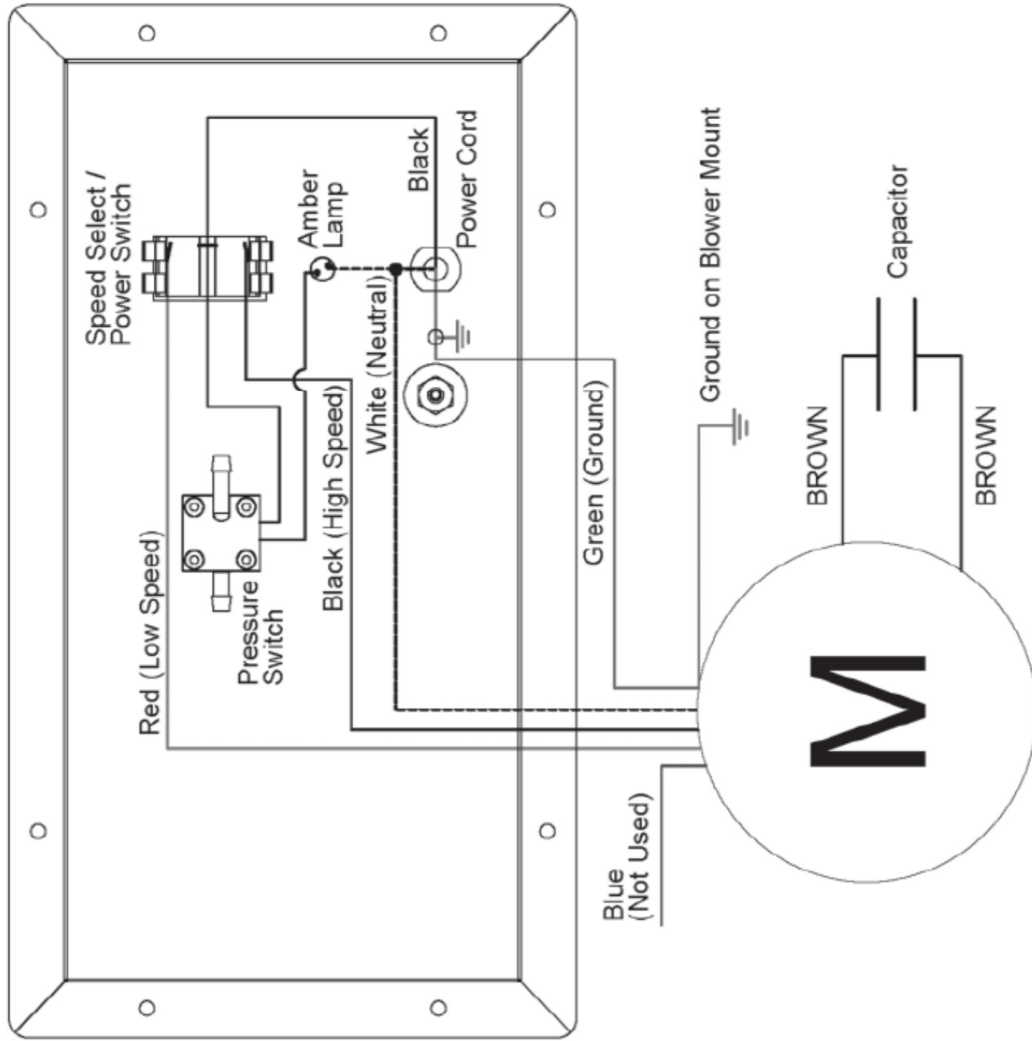

H2KM Wiring Schematic

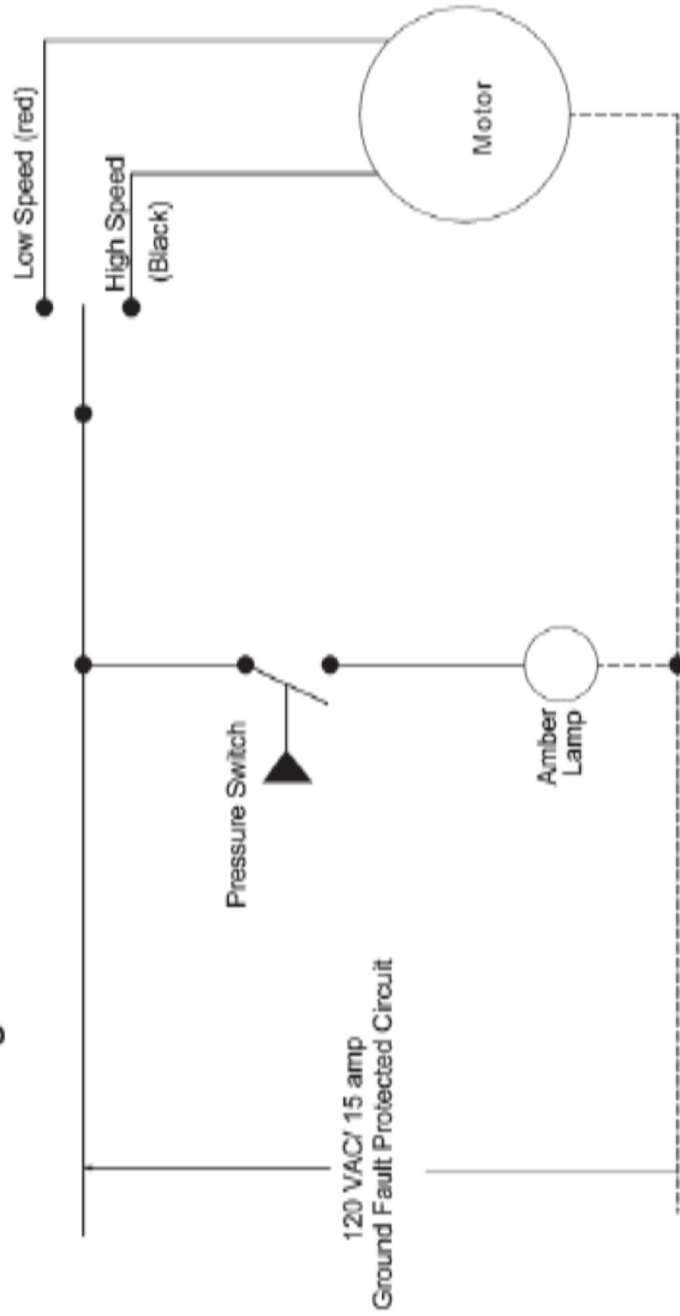

H2KMA Control Panel Wiring Diagram

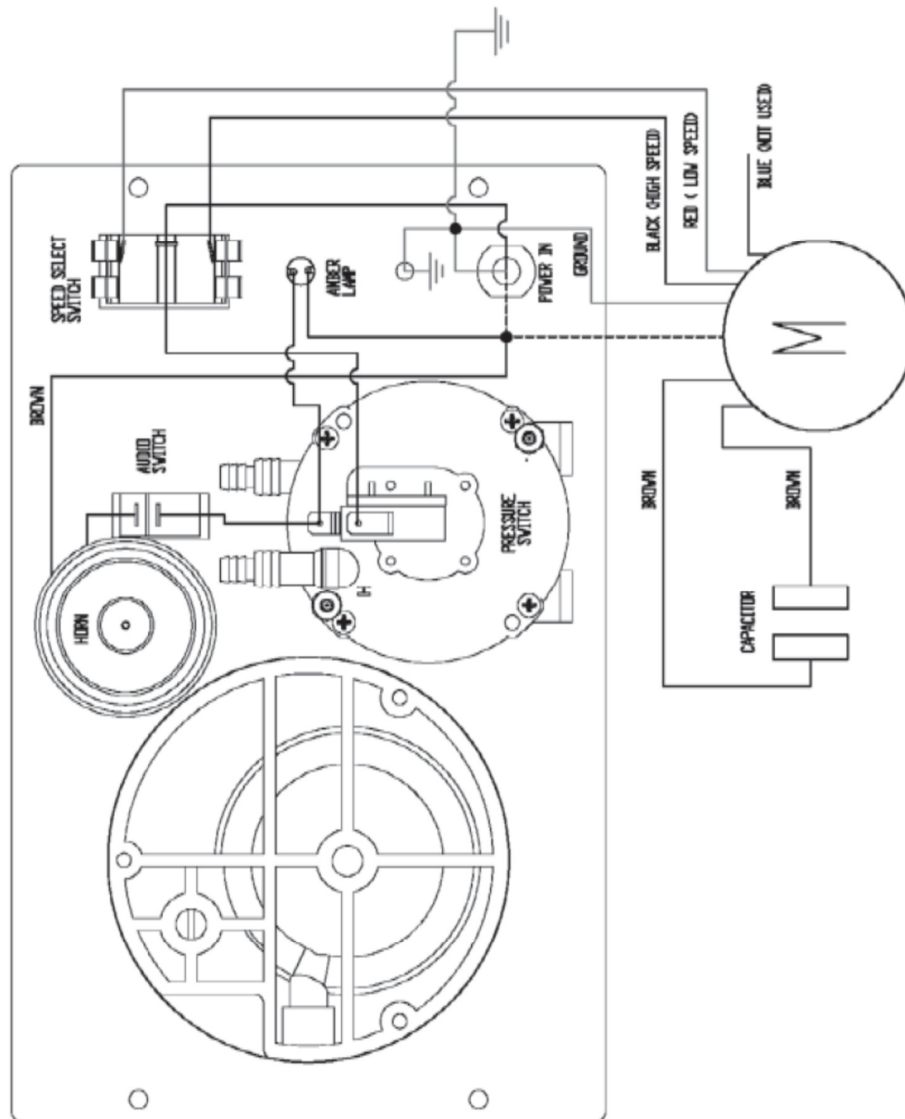

H2KMA Wiring Schematic

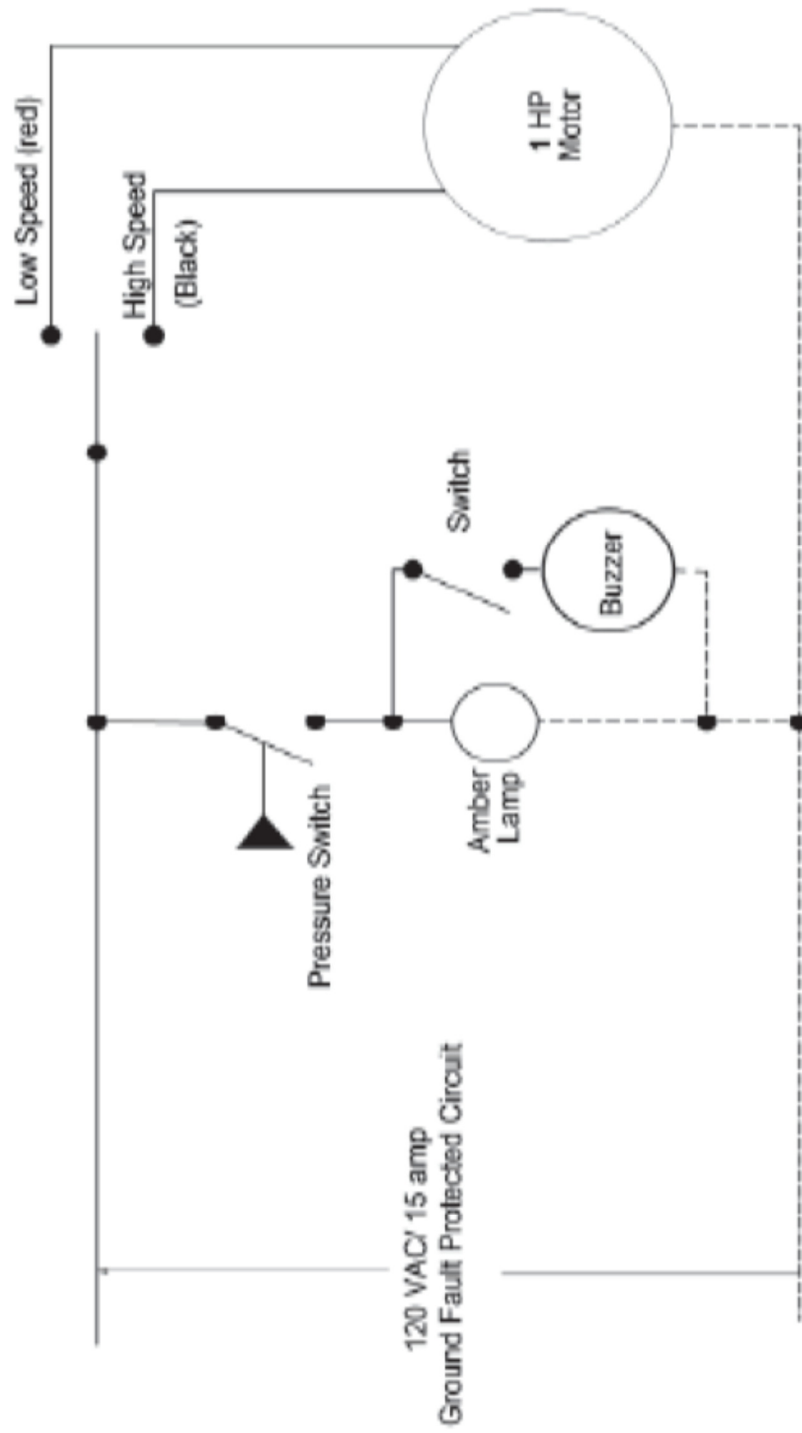

H2KM

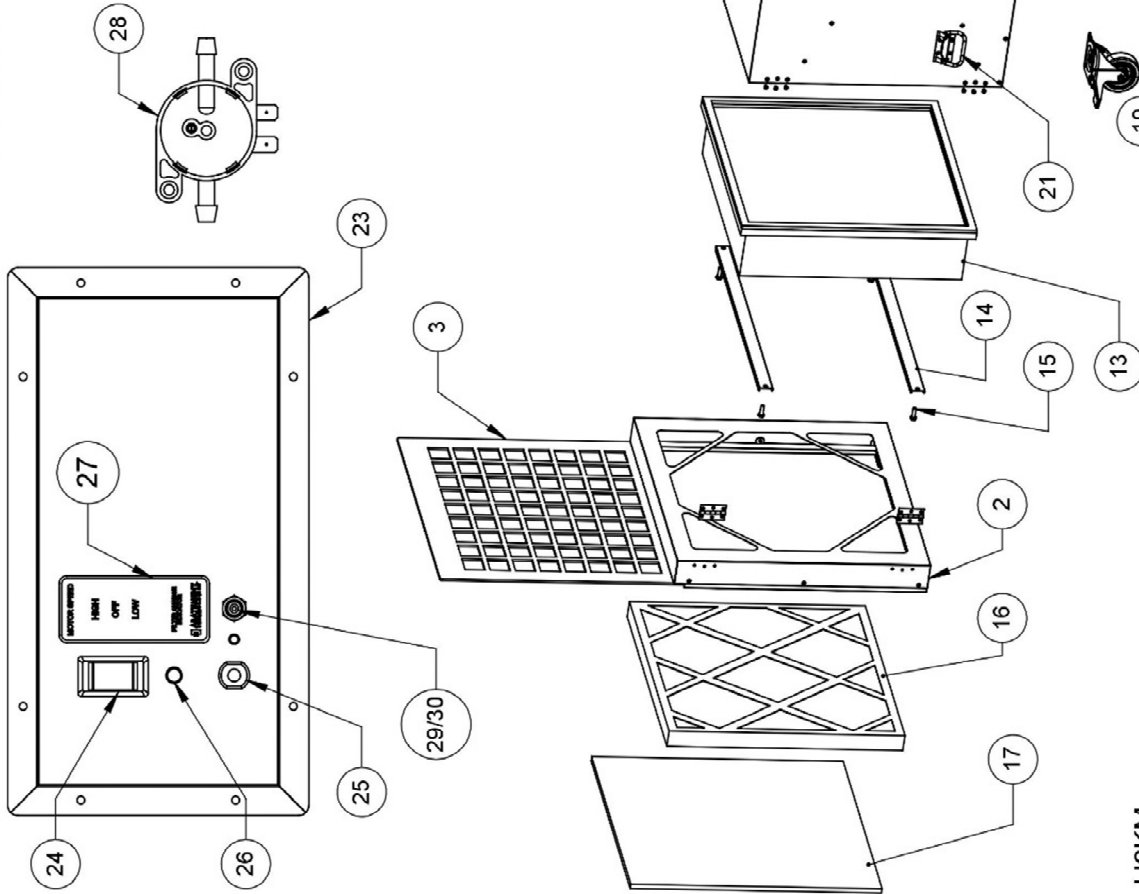

ITEM	PART NUMBER	DESCRIPTION	QTY.
1	CABINET46	ASSEMBLED CABINET	1
2	DOORASSY43	ASSEMBLE DOOR	1
3	3146	DROP DOWN DOOR	1
4	BLWRASYS4	MOTOR BLOWER ASSEMBLY	1
5	BLOWER33	BLOWER ASSEMBLY	1
6	MOTRZ1	1 HP MOTOR	1
7	HRDWARE118	MOUNTING ARM	3
8	HRDWARE119	BELLY BAND	1
9	2947	BLOWER BRACKETS	2
10	ELE163	CAPACITOR	1
11	2951	BACK PANEL	1
12	2000	OUTLET RING	1
13	H242406-99	99.97% HEPA FILTER	1
NOTE: H2010 HEPA FILTER OPTION IN PLACE OF M-PAK			
14	2645	HEPA RETAINING BRACKETS	2
15	SCREW25	5/16-18x1" HEX SCREW	4
16	H2002	PLEATED PREFILTER	1
17	H2001	PAD FILTER	1
18	CASTER42	3 1/2" CASTER, FIXED	2
19	CASTER43	3 1/2" CASTER, SWIVEL	3
20	SCREW31	5/16-18x1/2" HEX SCREW	16
21	HARDWARE23	HANDLE	4
22	CNTRLPLN193	CONTROL PANEL	1
23	2946	CONTROL PANEL PLATE	1
24	SWITCH02	ON/OFF SWITCH	1
25	ELE02	STRAIN RELIEF	1
26	LAMP09	AMBER SILICO LAMP	1
27	LABEL116	CONTROL PANEL LABEL	1
28	SWITCH23	PRESSURE SWITCH 1.7" W/C	1
29	HRDWARE20	HOSE BARB	1
30	NUT19	NYLON NUT	1
NOT SHOWN IN EXPLODED VIEW			
30	WIRE12	18Ga. POWER CORD	1

H2KM
3/23/17

H2KMA

ITEM	PART NUMBER	DESCRIPTION	QTY.
1	CABINET/46	ASSEMBLED CABINET	1
2	800PASS143	ASSEMBLED DOOR	1
3	3146	DROP DOWN DOOR	1
4	BLW06154	MOTOR BLOWER ASSEMBLY	1
5	BLOWER ASSEMBLY	BLOWER ASSEMBLY	1
6	MOTOR	1 HP MOTOR	1
7	HR24AR618	MOUNTING ARM	3
8	HR24AR619	BELLY BAND	1
9	2947	BLOWER BRACKETS	2
10	EL163	CAPACITOR	1
11	2948	BACK PANEL	1
12	2000	OUTLET RING	1
13	HR24AR6-99	99972 HEPA FILTER	1
14	2645	HEPA RETAINING BRACKETS	2
15	S05EM25	5/16-18X1/2 HEX SCREW	4
16	HR02	PLEATED PER-FILTER	1
17	HR00	PRO FILTER	1
18	CASTER/42	4" CASTER, FIXED	2
19	CASTER/43	4" CASTER, SWIVEL	3
20	S05EV31	5/16-18X1/2 HEX SCREW	16
21	HR24AR623	HANDLE	4
22	CTRLPIL95	CONTROL PANEL	1
23	2949	CONTROL PANEL PLATE	1
24	SW1002	ON/OFF SWITCH	1
25	SW1006	ALARM ON/OFF SWITCH	1
26	EL102	STRAIN RELIEF	1
27	LAMP09	AMBER SILICO LAMP	1
28	HR-2005	DIFFERENTIAL PRESSURE GAUGE 1-5"	1
29	HR24AR620	HOSE BARB	1
30	NUT19	NYLON NUT	1

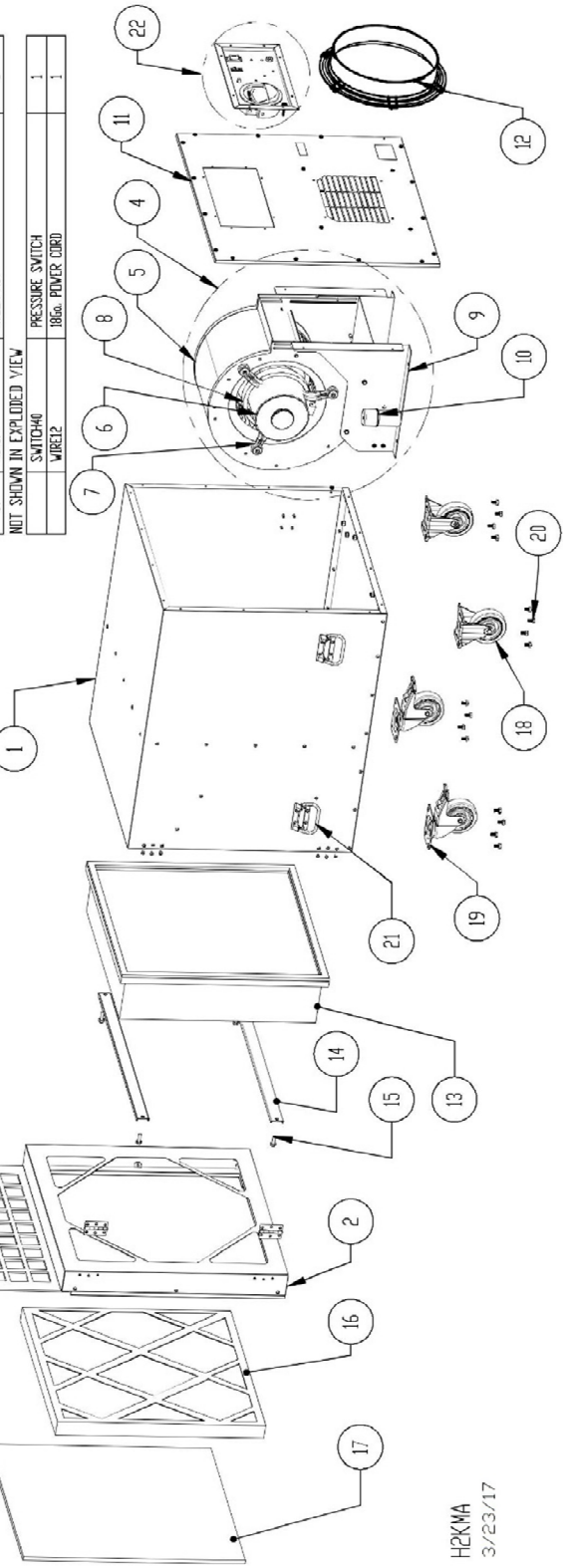

H2KMA
3/23/17